

## Instrument Accessories - Junction Boxes

**Mfr. Part No./Code    Description**

3-8050  
**159 000 184**

The Universal Mount Kit mounts a ProcessPro® field mount instrument onto a wall, pipe, or tank via a universal mounting plate.

- Compatible with:
- 8250-2
  - 8350-1 or -2
  - 8450-1 or -2
  - 8550-1 or -2
  - 8750-1 or -2
  - 8850-1 or -2

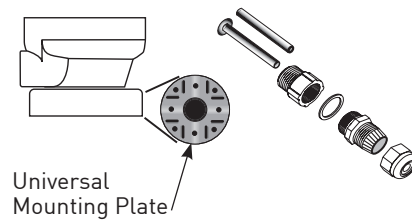

3-8050-1  
**159 000 753**

The Universal Mount Junction Box contains two terminal blocks that enable cable extensions for pH, ORP, flow, temperature, pressure, and conductivity sensors/electrodes (DO NOT extend resistivity electrode cable when resistivity value is above 10 MΩ). This kit mounts on a wall, pipe, or tank via a universal mounting plate.

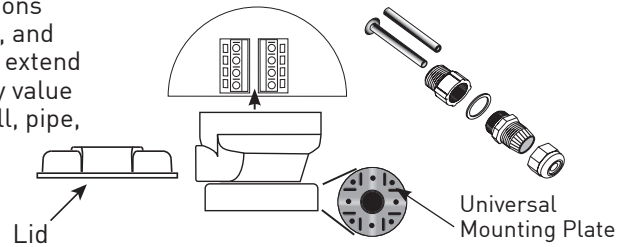

3-8050-2  
**159 000 754**

The pH/ORP Universal Mount Junction Box contains two terminal blocks that enable cable extension of pH or ORP sensors. It features an EasyCal board for simple, push-button pH or ORP calibration. This kit mounts on a wall, pipe, or tank via a universal mounting plate.

- Compatible ONLY with:
- 2750-1,
  - 2750-3
  - 2750-4

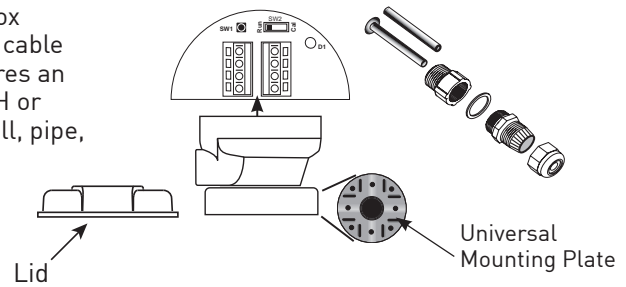

3-8051  
**159 000 187**

The Integral Mount Kit is designed to mount a ProcessPro® field mount instrument directly on top of a flow sensor.

- Compatible flow instruments
- 8150-1
  - 8550-1
  - 8550-2

- Compatible flow sensors:
- 8510-P0, -P1, -T0, or -V0
  - 8512-P0, -P1, -T0, or -V0.

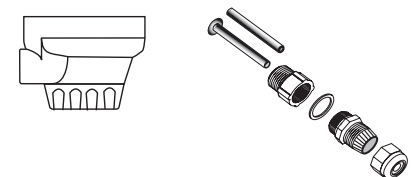

3-8052  
**159 000 188**

The Integral Mount Kit is designed to mount a ProcessPro® field mount instrument directly on top of a conductivity/resistivity, temperature, or pressure or level sensor.

- Compatible instruments:
- 8250-2
  - 8250-3
  - 8850-1
  - 8850-2
  - 8850-3
  - 8350-1
  - 8350-2
  - 8450-1
  - 8450-2

- Compatible sensors/electrodes:
- 2839-2842 Electrodes (-1, -1D versions)
  - 2350-2
  - 2450 (-2U, -4U, -2L, -4L, 2H, -4H versions)

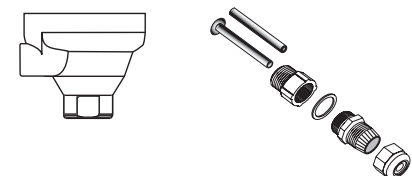

# Instrument Accessories and Replacement Parts

Note: Not all accessories shown pictorially.

## Instrument mounting

Mfr. Part No.	Code	Description	Compatibility	
	3-0000.596	159 000 641	Heavy Duty Wall Mnt. Bracket	for all instruments (panel mount version)
Mounting Bracket (3-5000.598)	3-0000.596-1	159 000 892	Heavy Duty Wall Mount when used with back cover 3-5000.395 or when used with back cover 3-8050.395	5075, 5090, 5091, 5500, 5600, 5700, 5800CR, 5900, 8250, 8350, 8450, 8550, 8750, 8850 (panel mount versions) 8860 and 8900
	3-0000.596-2	159 000 893	Heavy Duty Wall Mnt. Bracket when used with back cover 3-8050.395	
	3-5000.390	159 000 323	Installation Kit	5075, 5090, 5091, 5500, 5600, 5700, 5800CR, 5900
	3-5000.395	198 840 227	Splashproof Back Cover Kit	5075, 5090, 5091, 5500, 5600, 5700, 5800CR, 5900
Splashproof Back Cover (3-5000.395, 3-8050.395)	3-5000.399	198 840 224	5" x 5" Adapter Kit	5075, 5090, 5091, 5500, 5600, 5700, 5800CR, 5900, 8900
	3-5000.598	198 840 225	Mounting Bracket	all instruments (panel mount version)
	3-8050	159 000 184	Universal Mount Kit	8550, 8750, 8850, 8350, 8450, 8250 (pipe, wall, tank mount version)
	3-8050-1	159 000 753	Universal Mount Junction Box	8550, 8750, 8850, 8350, 8450, 8250 (pipe, wall, tank mount version)
	3-8050.392	159 000 640	200 Retrofit Adapter	5075, 5090, 5091, 5500, 5600, 5700, 5800CR, 5900, 8900
5 x 5 Adapter Kit (3-5000.399)	3-8050.395	159 000 186	Splashproof rear cover	8550, 8750, 8850, 8860, 8350, 8450, 8250, 8900 (panel mount version)
	3-8051	159 000 187	Flow sensor Integral Mount Kit	8550 (integral version)
	3-8052	159 000 188	3/4 in. Integral Mount Kit	8350, 8450, 8850 (integral version)
	3-8052-1	159 000 755	3/4 in. Junction Box	8350, 8450, 8850

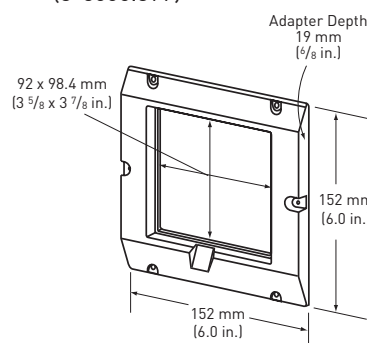
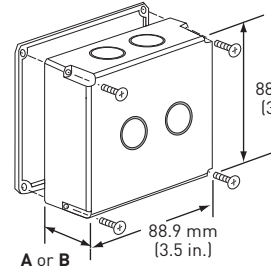
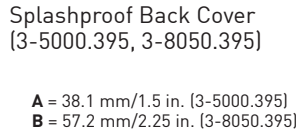
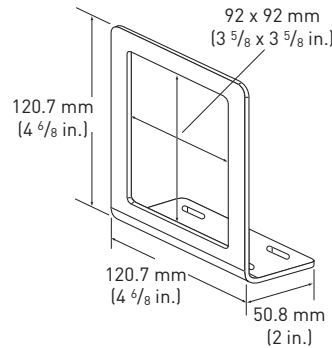

Heavy Duty Wall Mount Brackets (3-0000.596, 3-0000.596-1, 3-0000.596-2)

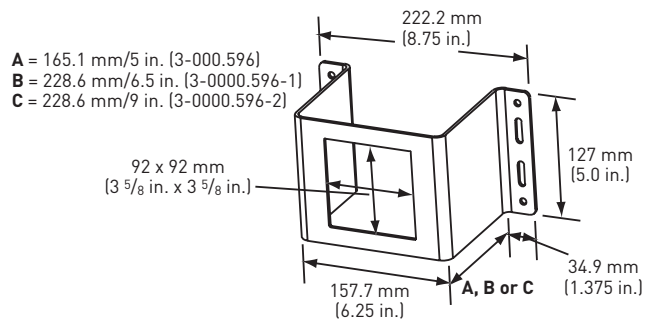

Liquid Tight Connectors (3-9000.392 (3 sets per kit), 3-9000.392-1 (1 set per kit), 3-9000.392-2 (1 set per kit))

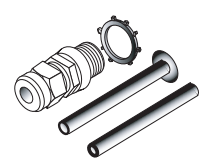

## Liquid Tight Connector Kits (for all instruments and junction boxes.)

Mfr. Part No.	Code	Description	Compatibility
3-9000.392	159 000 368	Liquid tight connector kit for rear cover (includes 3 connectors)	All instruments
3-9000.392-1	159 000 839	Liquid tight connector kit, NPT (1 pc.)	All instruments
3-9000.392-2	159 000 841	Liquid tight connector kit, PG13.5 (1 pc.)	All instruments

## Instrument Accessories and Replacement Parts

200 Retrofit Adapter  
(3-8050.392)

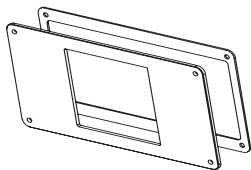

Unit Tags (3-5090.611 shown)

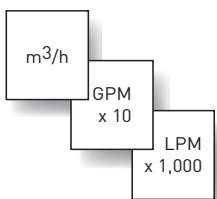

Dial kit (3-5090.390)



5090 and 5091 Window  
Kit (3-5000.396)

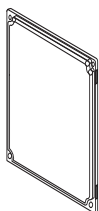

5000 series Window  
Kit (3-5000.397)

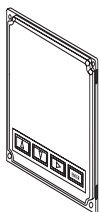

Bezel (3-5000.525.1)

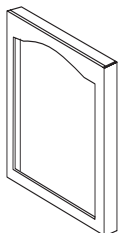

Protective Overlay Kit  
(3-5000.398)

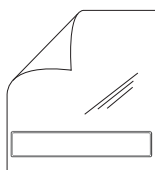

### Power Supply, RC Filter, Batteries, and 4 to 20 mA to Digital Converter.

Mfr. Part No.	Code	Description	Compatibility
7300-7524	<b>159 000 687</b>	24 VDC Power Supply 7.5 W, 300 mA	See instrument specifications
7300-1524	<b>159 000 688</b>	24 VDC Power Supply 15 W, 600 mA	See instrument specifications
7300-3024	<b>159 000 689</b>	24 VDC Power Supply 30 W, 1.3 A	See instrument specifications
7300-5024	<b>159 000 690</b>	24 VDC Power Supply 50 W, 2.1 A	See instrument specifications
7300-1024	<b>159 000 691</b>	24 VDC Power Supply 100 W, 4.2 A	See instrument specifications
3-8050.396	<b>159 000 617</b>	RC Filter Kit - 2 per kit (for use with relays)	8550, 8750, 8850, 8860, 8250, 8350, 8450
3-5000.075	<b>159 000 321</b>	Power Supply 110V/24V	5000 Series Instruments
7400-0011	<b>159 000 935</b>	Lithium Repl. Battery (2 required)	8150
3-8058-1	<b>159 000 966</b>	4 to 20 mA to Digital Converter (Wire Mount)	8900
3-8058-2	<b>159 000 967</b>	4 to 20 mA to Digital Converter (DIN Mount)	8900
3-8058-1S	<b>special order</b>	4 to 20 mA to Digital Converter (Wire Mount)	8250, 8350, 8450
3-8058-2S	<b>special order</b>	4 to 20 mA to Digital Converter (DIN Mount)	8250, 8350, 8450

### Instrument Tags

Mfr. Part No.	Code	Description	Compatibility
3-5090.611	<b>198 840 228</b>	Unit tags	5090
3-5500.611	<b>159 840 230</b>	Unit tags	5075, 5500, 5600, 5800CR

### Instrument Dial and Window Kits

Mfr. Part No.	Code	Description	Compatibility
3-5500.390	<b>159 000 347</b>	Dial Kit	5075, 5500, 5600, 5800CR
3-5090.390	<b>159 000 334</b>	Dial Kit	5090
3-5000.396	<b>159 000 325</b>	Window Kit	5090
3-5000.397	<b>159 000 326</b>	5000 Series Window Kit	5075, 5090, 5500, 5600, 5700, 5800CR, 5900
3-5000.398	<b>159 000 646</b>	Protective overlay kit (10 pieces)	5075, 5090, 5500, 5600, 5700, 5800CR, 5900
3-5000.525-1	<b>198 840 226</b>	Bezel	5075, 5090, 5500, 5600, 5700, 5800CR, 5900

### Multi-Parameter Accessories and Replacement Parts

Mfr. Part No.	Code	Description	Compatibility
3-8900.390	<b>159 000 891</b>	DB-9 Crossover Cable	8900
3-8900.391	<b>159 000 918</b>	Real Panel w/captive screws	8900
3-8900.561	<b>159 000 919</b>	Front face panel gasket	8900
3-8900.602	<b>159 000 904</b>	2 two-terminal plug	8900
3-8900.604	<b>159 000 903</b>	4-terminal plug	8900
3-8900.606	<b>159 000 937</b>	6-terminal plug	8900
3-8900.614	<b>159 000 902</b>	14-terminal plug	8900

# Flow Sensor Accessories and Replacement Parts

## Rotors and Rotor Kits

Rotor

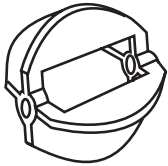

Sleeved Rotor  
(pin not included)

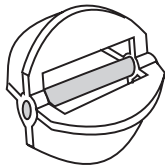

Rotor pin



Rotor Kit (P52509)

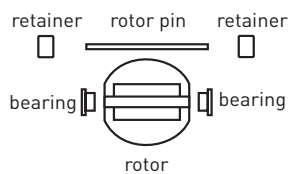

Mfr. Part No.	Code	Description	Compatibility
M1538-2	<b>198 801 181</b>	Rotor and Pin (matched set), PVDF Black	515
P51547-3	<b>159 000 474</b>	Rotor and Pin (matched set), PVDF Natural	515
P51550-3	<b>198 820 043</b>	Rotor and Pin, PVDF Natural	515
M1538-4	<b>198 820 018</b>	Rotor, Tefzel®	515
3-0515.322-1	<b>198 820 059</b>	Sleeved Rotor, PVDF Black	515
3-0515.322-2	<b>198 820 060</b>	Sleeved Rotor, PVDF Natural	515
3-0515.322-3	<b>198 820 017</b>	Sleeved Rotor, Tefzel®	515
3-2507.080-2	<b>159 000 254</b>	Rotor	2507
P52509	<b>198 801 501</b>	Rotor kit (rotor, stainless steel pin, bearings, retainers)	525
P52509-1	<b>159 000 479</b>	Rotor Kit (rotor, stainless steel pin, bearings, retainers)	2517
P52509-2	<b>159 000 480</b>	Rotor kit (rotor, tungsten carbide pin, bearings, retainers)	525
P52509-3	<b>159 001 068</b>	Rotor kit (rotor, tungsten carbide pin, bearings, retainers)	2517
3-2540.320	<b>198 820 040</b>	Rotor Kit, 2540 Peek Bearing (old version)	2540
3-2540.321	<b>159 000 623</b>	Rotor Kit, 2540 Tungsten Carbide Pin (new version since 1.1.2000)	2540
3-2540.322	<b>159 000 864</b>	Rotor Kit, ss pin and rotor	2540
3-2536.320-1	<b>198 820 052</b>	Rotor, PVDF Black	2536, 2537
3-2536.320-2	<b>159 000 272</b>	Rotor, PVDF Natural	2536, 2537
3-2536.320-3	<b>159 000 273</b>	Rotor, Tefzel®	2536, 2537
3-2536.321	<b>198 820 054</b>	Rotor and Pin (matched set), PVDF Natural	2536, 2537
3-2536.322-1	<b>198 820 056</b>	Sleeved Rotor, PVDF Black	2536, 2537
3-2536.322-2	<b>198 820 057</b>	Sleeved Rotor, PVDF Natural	2536, 2537
3-2536.322-3	<b>198 820 058</b>	Sleeved Rotor, Tefzel®	2536, 2537
3-2000.390	<b>159 000 248</b>	Replacement Rotor Kit	2000

## Rotor Pins

Mfr. Part No.	Code	Description	Compatibility
M1546-1	<b>198 801 182</b>	Pin, Titanium	515, 2536, 2537
M1546-2	<b>198 801 183</b>	Pin, Hastelloy-C	515, 2536, 2537
M1546-3	<b>198 820 014</b>	Pin, Tantalum	515, 2536, 2537
M1546-4	<b>198 820 015</b>	Pin, Stainless Steel	515, 2536, 2537
P51545	<b>198 820 016</b>	Pin, Ceramic	2536, 2537

## Rotor Shafts

Mfr. Part No.	Code	Description	Compatibility
P52504-1	<b>198 801 500</b>	Rotor Shaft, Stainless steel 316 (optional)	525
P52504-2	<b>198 820 023</b>	Rotor Shaft, Tungsten Carbide (standard)	525

## Bearings

Mfr. Part No.	Code	Description	Compatibility
P52503	<b>198 820 013</b>	Bearing, Fluoroloy B®	525, 2517
3-2540.520	<b>159 000 648</b>	Bearing, Fluoroloy B®	2540

## Flow Sensor Accessories and Replacement Parts

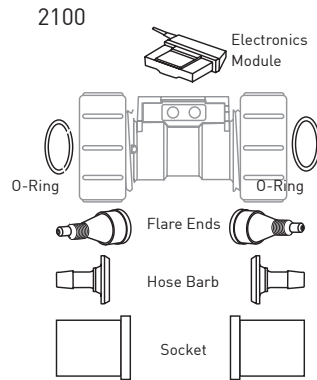

### Turbines

Mfr. Part No.	Code	Description	Compatibility
3-2100.390-1L	<b>159 000 015</b>	Turbine Lo Flow with FPM O-rings (replacement body)	2100
3-2100.390-1H	<b>159 000 016</b>	Turbine Hi Flow with FPM O-rings (replacement body)	2100
3-2100.390-2L	<b>159 000 017</b>	Turbine Lo Flow with EPDM O-rings (replacement body)	2100
3-2100.390-2H	<b>159 000 018</b>	Turbine Hi Flow with EPDM O-rings (replacement body)	2100
2100.390	<b>159 000 014</b>	Electronics Module with cable	2100

### In-line Rotors

Mfr. Part No.	Code	Description	Compatibility
3-2507.081-2	<b>198 801 502</b>	2 mm Insert	2507
3-2507.081-3	<b>198 801 503</b>	3 mm Insert	2507
3-2507.081-4	<b>198 801 558</b>	4 mm Insert	2507
3-2507.080-5	<b>159 000 256</b>	DIN Connector	2507

### Ultrasonic Doppler Flowmeter Accessories

Mfr. Part No.	Code	Description	Compatibility
3-3200.075	<b>159 000 973</b>	Battery - sealed lead acid 6V 12Ah (Panasonic LC-R0612P)	3300, 3500
3-3200.076	<b>159 000 975</b>	Solar panel - Solarex 6V 5W MSX5V6	3300, 3500
3-3200.395	<b>159 000 976</b>	Solar panel mounting kit	3300, 3500
3-3200.090	<b>159 000 977</b>	Signet FloCom™ CD Doppler operating system and instructions (Win32)	3300, 3500
3-3200.391	<b>159 000 979</b>	Communication cable to connect 3300 to PC	3300, 3500

## Flow Sensor Accessories and Replacement Parts

### Magmeter Flow Sensor Accessories

Mfr. Part No.	Code	Description	Compatibility
<b>Replacement Transducers</b>			
3-2551-P0	<b>159 001 211</b>	PP/316LSS, DN15 to DN100 (0.5 to 4 in.) pipe	2551
3-2551-P1	<b>159 001 212</b>	PP/316LSS, DN125 to DN200 (5 to 8 in.) pipe	2551
3-2551-P2	<b>159 001 444</b>	PP/316LSS, DN250 to DN300 (10 to 12 in.) pipe	2551
3-2551-T0	<b>159 001 213</b>	PVDF/Titanium, DN15 to DN100 (0.5 to 4 in.) pipe	2551
3-2551-T1	<b>159 001 214</b>	PVDF/Titanium, DN125 to DN200 (5 to 8 in.) pipe	2551
3-2551-T2	<b>159 000 445</b>	PVDF/Titanium, DN250 to DN300 (10 to 12 in.) pipe	2551
3-2551-V0	<b>159 001 376</b>	PVDF/Hastelloy-C, DN15 to DN100 (0.5 to 4 in.) pipe	2551
3-2551-V1	<b>159 001 377</b>	PVDF/Hastelloy-C, DN125 to DN200 (5 to 8 in.) pipe	2551
3-2551-V2	<b>159 000 446</b>	PVDF/Hastelloy-C, DN250 to DN300 (10 to 12 in.) pipe	2551
3-2551-W0	<b>159 001 234</b>	PVDF/316LSS, DN15 to DN100 (0.5 to 4 in.) pipe	2551
3-2551-W1	<b>159 001 235</b>	PVDF/316LSS, DN125 to DN200 (5 to 8 in.) pipe	2551
3-2551-W2	<b>159 001 447</b>	PVDF/316LSS, DN250 to DN300 (10 to 12 in.) pipe	2551
<b>Replacement Electronics Module</b>			
3-2551-11	<b>159 001 215</b>	Magmeter electronics, frequency or digital (S <sup>3</sup> L) output	2551
3-2551-12	<b>159 001 215</b>	Magmeter electronics, 4 to 20mA output	2551
3-2551-21	<b>159 001 372</b>	Magmeter Display Electronics, frequency or digital (S <sup>3</sup> L) output	2551
3-2551-22	<b>159 001 373</b>	Magmeter Display Electronics, 4 to 20mA output	2551
3-2551-41	<b>159 001 374</b>	Magmeter Display Electronics, frequency or digital (S <sup>3</sup> L) output, w/relays	2551
3-2551-42	<b>159 001 375</b>	Magmeter Display Electronics, frequency or digital (S <sup>3</sup> L) output, w/relays	2551
<b>Other</b>			
3-8551.521	<b>159 001 378</b>	Clear plastic cap for display	2551
2120-1512	<b>159 001 425</b>	1.5 in. x 1.25 in. NPT adapter	2552
2120-2012	<b>159 001 426</b>	2 in. x 1.25 in. NPT adapter	2552
4301-2125	<b>159 001 533</b>	1.25 in. NPT, full port ball valve-brass	2552
4301-3125	<b>159 001 387</b>	1.25 in. NPT, female to female full port ball valve, 316SS	2552
5541-4184	<b>159 001 388</b>	Cable, 4 cond., 22 AWG, 4m (13 ft)	2552
5541-4186	<b>159 001 389</b>	Cable, 4 cond., 22 AWG, 6m (19.5 ft)	2552
3-2552.392	<b>159 001 530</b>	1.25 in. NPT, full port ss ball valve and nipple kit	2552
3-2552.393	<b>159 001 531</b>	1.25 in. NPT, full port brass ball valve and nipple kit	2552
3-2552.394	<b>159 001 532</b>	1.5 in. NPT, conduit adapter, aluminum	

# Flow Sensor Accessories and Replacement Parts

## O-Rings and Gaskets

Mfr. Part No.	Code	Description	Compatibility
1220-0018	<b>159 000 019</b>	O-rings FPM (2 required per sensor)	2100
1220-0021	<b>198 801 186</b>	O-ring, FPM-Viton® (2 per sensor)	515, 2536, 2537
1220-0029	<b>198 820 049</b>	Cover O-ring	2000
1223-0151	<b>159 000 236</b>	Cap O-ring	7000, 7001
1220-0121	<b>159 000 852</b>	O-ring, Viton® (2 required per sensor)	2517, 2540
1224-0018	<b>159 000 020</b>	O-rings EPDM (2 required per sensor)	2100
1224-0021	<b>198 820 006</b>	O-ring, EPR (2 required per sensor)	515, 2536, 2537, 2517, 2540
1224-0205	<b>159 000 836</b>	O-ring, EPDM (2 required per sensor)	515
1228-0021	<b>198 820 007</b>	O-ring, FFPM (2 required per sensor)	515, 2536, 2537, 2540
3-2507.080-3	<b>159 000 255</b>	Quad Ring	2507
3-7000.390-01	<b>159 000 563</b>	O-ring, DN15, 0.5", EPDM	7000, 7001
3-7000.390-02	<b>159 000 564</b>	O-ring, DN20, 0.75", EPDM	7000, 7001
3-7000.390-03	<b>159 000 565</b>	O-ring, DN25, 1.0", EPDM	7000, 7001
3-7000.390-04	<b>159 000 566</b>	O-ring, DN32, 1.25", EPDM	7000, 7001
3-7000.390-05	<b>159 000 567</b>	O-ring, DN40, 1.5", EPDM	7000, 7001
3-7000.390-06	<b>159 000 568</b>	O-ring, DN50, 2.0", EPDM	7000, 7001
3-7000.390-07	<b>159 000 569</b>	O-ring, DN15, 0.5", FPM	7000, 7001
3-7000.390-08	<b>159 000 570</b>	O-ring, DN20, 0.75", FPM	7000, 7001
3-7000.390-09	<b>159 000 571</b>	O-ring, DN25, 1.0", FPM	7000, 7001
3-7000.390-10	<b>159 000 572</b>	O-ring, DN32, 1.25", FPM	7000, 7001
3-7000.390-11	<b>159 000 573</b>	O-ring, DN40, 1.5", FPM	7000, 7001
3-7000.390-12	<b>159 000 574</b>	O-ring, DN50, 2.0", FPM	7000, 7001
P52618	<b>159 000 493</b>	Gasket	525
1222-0032	<b>159 000 234</b>	PTFE Coated O-ring	7000, 7001
1222-0042	<b>159 001 379</b>	O-ring for clear plastic cap, EPDM	2551

Liquid Tight Connector kit (3-0000.393)

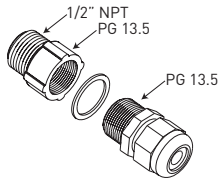

Conduit Adapter Kit

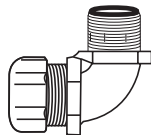

Sensor Cap



Sensor Plug

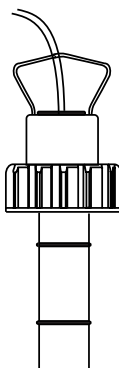

## Miscellaneous

Mfr. Part No.	Code	Description	Compatibility
3-0000.393	<b>159 000 618</b>	Liquid Tight Connector Kit with PG13.5 to NPT Adapter	7000
3-1500.663	<b>198 820 008</b>	Hot-Tap Installation Tool (See page Installation for more information)	2517, 2540
3-8050	<b>159 000 184</b>	Universal Adapter Kit	7000
1203-1121	<b>198 864 920</b>	Base Seal	7000, 7001
P31520-1V	<b>159 000 460</b>	Pipe Adapter Insert, PVDF	5 in. to 8 in. pipe fittings
P31520-2P	<b>159 000 461</b>	Pipe Adapter Insert, PVC	5 in. to 8 in. pipe fittings
P31536	<b>198 840 201</b>	Sensor Plug, Polypro	515, 2536, 2537
P31536-2	<b>159 000 649</b>	Sensor Plug, PVDF	515, 2536, 2537
P31542	<b>198 801 630</b>	Sensor Cap, Red	515
P31542-3	<b>159 000 464</b>	Sensor Cap, Blue	2536
P3167-1	<b>159 000 465</b>	Pipe Adapter Insert, PVDF 1.5 in.	1.5 in. pipe fittings
P31934	<b>159 000 466</b>	Conduit Cap	515, 2517, 2536, 2540
2450-0620	<b>198 820 051</b>	Cover screw	2000
3-2541.260-1	<b>159 000 849</b>	Standard replacement electronics module	2540
3-2541.260-2	<b>159 000 850</b>	Hot-Tap replacement electronics module	2540
P52527	<b>159 000 481</b>	Retainers, SS (1.4401)	525, 2540
P52628	<b>159 000 504</b>	Fitting cap kit (cap and gasket)	525
P51589	<b>159 000 476</b>	Conduit Adapter Kit	515, 525, 2517, 2536, 2540
5523-0222	<b>159 000 392</b>	Cable (per ft), 2 cond., w/shield, 22 AWG	515, 2517, 2507, 2000, 2540
5523-0322	<b>159 000 761</b>	Cable (per ft), 3 cond., w/shield, 22 AWG	8058
5523-3222	<b>159 000 393</b>	Cable (per ft), 2 cond., w/shield 22 AWG	525

# pH/ORP Sensor Accessories and Replacement Parts

## pH/ORP Electrode Mounting

Pipe Adapter, 1.25 in. OD.  
For use with:  
Signet 2714-2717 pH/ORP  
Signet 2754-2757 pH/ORP

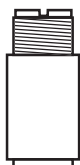

Mfr. Part No.	Code	Description	Compatibility
P31515-0P200	<b>159 000 630</b>	PVC Pipe Adapter, 1.25 in. o.d.	2714, 2715, 2716, 2717 2754, 2755, 2756, 2757
P31515-0C200	<b>159 000 631</b>	CPVC Pipe Adapter, 1.25 in. o.d.	2714, 2715, 2716, 2717 2754, 2755, 2756, 2757
P31515-0V200	<b>159 000 459</b>	PVDF Pipe Adapter, 1.25 in. o.d.	2714, 2715, 2716, 2717 2754, 2755, 2756, 2757
P31542	<b>198 801 630</b>	Red sensor cap for in-line sensor installations	2714, 2715, 2716, 2717
P31542-3	<b>159 000 464</b>	Blue sensor cap for in-line sensor installations	2714, 2715, 2716, 2717

Sensor Cap



## pH/ORP Miscellaneous

Pipe Adapter, 1.5 in. to 1 in. FNPT. For use with:  
Signet 2764-2767

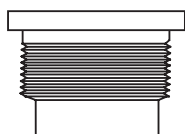

Mfr. Part No.	Code	Description	Compatibility
1220-0021	<b>198 801 186</b>	O-ring, FPM	2714, 2715, 2716, 2717 2754, 2755, 2756, 2757
1224-0021	<b>198 820 006</b>	O-ring, EPDM	2714, 2715, 2716, 2717 2754, 2755, 2756, 2757
1228-0021	<b>198 820 007</b>	O-ring, Kalrez®	2714, 2715, 2716, 2717 2754, 2755, 2756, 2757
5523-0624	<b>159 000 636</b>	Cable, 24 AWG, 6-conductor (specify length in feet or meters)	2714, 2715, 2716, 2717
3-2721	<b>198 864 610</b>	Remote pH/ORP preamplifier	2764-2767
3864-0001	<b>159 001 007</b>	Replacement Salt Bridge	2764-2767
3864-0002	<b>159 001 008</b>	Replacement Reference Electrolyte Solution 500 ml	2764-2767
2120-0015	<b>159 001 009</b>	CPVC Adapter, 1.5 in. MNPT to 1 in. FNPT	2764-2767
2122-0015	<b>159 001 010</b>	316SS (1.4401) Adapter, 1.5 in. MNPT to 1 in. FNPT	2764-2767



# Wet-Tap and Miscellaneous Accessories and Replacement Parts

## Mounting Saddles for Wet-Tap

PP Clamp-on Saddle

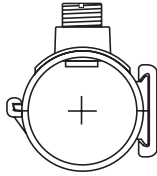

NPT Fitting



2842 Replacement Insulator

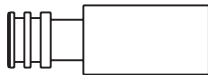

Mfr. Part No.	Code	Description	Compatibility
2007-0225	<b>159 000 812</b>	PP Clamp-on Saddle, 2.5 in. x 1.5 in. (ASTM, NPT)	3719 Wet-Tap
2007-0230	<b>159 000 813</b>	PP Clamp-on Saddle, 3 in. x 1.5 in. (ASTM, NPT)	3719 Wet-Tap
2007-0240	<b>159 000 814</b>	PP Clamp-on Saddle, 4 in. x 1.5 in. (ASTM, NPT)	3719 Wet-Tap
2007-0260	<b>159 000 815</b>	PP Clamp-on Saddle, 6 in. x 2 in. (ASTM, NPT)	3719 Wet-Tap
2007-0280	<b>159 000 816</b>	PP Clamp-on Saddle, 8 in. x 2 in. (ASTM, NPT)	3719 Wet-Tap
2007-0210	<b>159 000 817</b>	PP Clamp-on Saddle, 10 in. x 2 in. (ASTM, NPT)	3719 Wet-Tap
2007-0212	<b>159 000 818</b>	PP Clamp-on Saddle, 12 in. x 2 in. (ASTM, NPT)	3719 Wet-Tap

## Wet-Tap Replacement Parts

Mfr. Part No.	Code	Description	Compatibility
1220-0114	<b>159 000 854</b>	3719 O-ring, FPM <small>(spare part)</small>	3719 Wet-Tap
3-3719.390	<b>159 000 855</b>	3719 Locking Shroud <small>(spare part)</small>	3719 Wet-Tap
1220-9458	<b>159 000 927</b>	3719 O-ring, FPM <small>(spare part)</small>	3719 Wet-Tap

## Miscellaneous

Mfr. Part No.	Code	Description	Compatibility
3-2842.390	<b>159 000 925</b>	2842 Replacement Insulator	2842
3-2820.392	<b>198 840 222</b>	1/2 in. NPT fitting, 316SS	2820-1, 2821-1
3-2820.390	<b>198 840 223</b>	3/4 in. NPT fitting, 316SS	2822-1
3-2820.391	<b>198 840 221</b>	3/4 in. NPT fitting, Polypro	2819-1, 2820-1, 2821-1
6205-0002	<b>159 000 858</b>	DIN Rail (1m length)	8058, 8059, 7300
6250-0003	<b>159 000 859</b>	End Clips for DIN Rail	8058, 8059, 7300
5523-0222	<b>159 000 392</b>	Cable (2 Conductors plus shield, 22 AWG, Red/Black)	8058, 8059, 7300
3-8050-2	<b>159 000 754</b>	Universal Mount Junction Box with EasyCal	2750
3-8052-2	<b>159 000 756</b>	3/4 in. NPT Mount Junction Box with EasyCal	2750
3-8050-1CR	<b>159 000 889</b>	Universal Mount Junction Box with CR Cell Ranges	2850
3-8050-2CR	<b>159 000 802</b>	Universal Mount Junction Box with CR EasyCal	2850
3-8052-1CR	<b>159 000 890</b>	3/4 in. NPT Mount Junction Box with CR Cell Ranges	2850
3-8052-2CR	<b>159 000 803</b>	3/4 in. NPT Mount Junction Box with CR EasyCal	2850